

# AXOR

DE / Gebrauchsanleitung / Montageanleitung	02
FR / Mode d'emploi / Instructions de montage	02
EN / Instructions for use / assembly instructions	03
IT / Istruzioni per l'uso / Istruzioni per l'installazione	03
ES / Modo de empleo / Instrucciones de montaje	04
NL / Gebruiksaanwijzing / Handleiding	04
DK / Brugsanvisning / Monteringsvejledning	05
PT / Instruções para uso / Manual de instalação	05
PL / Instrukcja obsługi / Instrukcja montażu	06
CS / Návod k použití / Montážní návod	06
SK / Návod na použitie / Montážny návod	07
ZH / 用户手册 / 组装说明	07
RU / Руководство пользователя / Инструкция по монтажу	08
HU / Használati útmutató / Szerelési útmutató	08
FI / Käyttöohje / Asennusohje	09
SV / Bruksanvisning / Monteringsanvisning	09
LT / Vartotojo instrukcija / Montavimo instrukcijos	10
HR / Upute za uporabu / Uputstva za instalaciju	10
TR / Kullanım kılavuzu / Montaj kılavuzu	11
RO / Manual de utilizare / Instrucțiuni de montare	11
EL / Οδηγίες χρήσης / Οδηγία συναρμολόγησης	12
SL / Navodilo za uporabo / Navodila za montažo	12
ET / Kasutusjuhend / Paigaldusjuhend	13
LV / Lietošanas pamācība / Montāžas instrukcija	13
SR / Uputstvo za upotrebu / Uputstvo za montažu	14
NO / Bruksanvisning / Montasjeveiledning	14
BG / Инструкция за употреба / Ръководство за монтаж	15
SQ / Udhëzuesi i përdorimit / Udhëzime rreth montimit	15
AR / عميلنا تاميلعت / مادختسلا ليلد	16

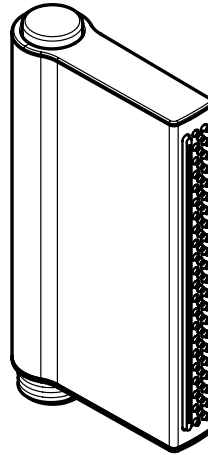

AXOR One  
45720000

## SICHERHEITSHINWEISE

- ⚠ Bei der Montage müssen zur Vermeidung von Quetsch- und Schnittverletzungen Handschuhe getragen werden.
- ⚠ Der Kontakt der Brausestrahlen mit empfindlichen Körperstellen (z. B. Augen) muss vermieden werden. Es muss ein ausreichender Abstand zwischen Brause und Körper eingehalten werden.
- ⚠ Die Brause darf nur zur Bade-, Hygiene- und Körperreinigungszwecke eingesetzt werden.

## MONTAGEHINWEISE

- / Der vormontierte Filtereinsatz muss verwendet werden, um den Normdurchfluss der Handbrause zu gewährleisten und um Schmutzeinspülungen aus dem Leitungsnetz zu vermeiden. Schmutzeinspülungen können die Funktion beeinträchtigen und/oder zu Beschädigungen an Funktionsteilen der Handbrause führen, für hieraus ergebende Schäden haftet Hansgrohe nicht

## TECHNISCHE DATEN

Betriebsdruck:	max. 0,6 MPa
Empfohlener Betriebsdruck:	0,25 - 0,4 MPa
	(1 MPa = 10 bar = 147 PSI)
Heißwassertemperatur:	max. 60°C
Thermische Desinfektion:	max. 70°C/4 min

Das Produkt ist ausschließlich für Trinkwasser konzipiert!

## SYMBOLERKLÄRUNG



MASSE (siehe Seite 18)



DURCHFLUSSDIAGRAMM  
(siehe Seite 18)



BEDIENUNG (siehe Seite 17)



SERVICETEILE (siehe Seite 17)



REINIGUNG (siehe Seite 17) und  
beiliegende Broschüre



PRÜFZEICHEN (siehe Seite 20)

## CONSIGNES DE SÉCURITÉ

- ⚠ Lors du montage, porter des gants de protection pour éviter toute blessure par écrasement ou coupure.
- ⚠ Éviter le contact du jet de la douchette avec les parties sensibles du corps (telles par ex. que les yeux). Veiller à respecter un écart suffisant entre la douchette et le corps
- ⚠ La douchette ne doit servir qu'à se doucher, à se nettoyer et à pratiquer une hygiène corporelle.

## INSTRUCTIONS POUR LE MONTAGE

- / La garniture filtrante prémontée doit être utilisée pour garantir le débit normal de la douchette et éviter l'infiltration de saletés provenant du réseau de conduites. Ces infiltrations de saletés risquent de porter préjudice et/ou d'endommager les éléments fonctionnels de la douchette et n'entrent pas dans le cadre de la responsabilité de Hansgrohe.

## INFORMATIONS TECHNIQUES

Pression de service autorisée:	max. 0,6 MPa
Pression de service conseillée:	0,25 - 0,4 MPa
	(1 MPa = 10 bar = 147 PSI)
Température d'eau chaude:	max. 60°C
Désinfection thermique:	max. 70°C/4 min

Le produit est exclusivement conçu pour de l'eau potable!

## DESCRIPTION DU SYMBOLE



DIMENSIONS (voir pages 18)



DIAGRAMME DU DÉBIT  
(voir pages 18)



INSTRUCTIONS DE SERVICE (voir  
pages 17)



PIÈCES DÉTACHÉES (voir pages 17)



NETTOYAGE (voir pages 17) et bro-  
chure ci-jointe



CLASSIFICATION ACOUSTIQUE  
ET DÉBIT (voir pages 20)

## SAFETY NOTES

- ⚠ Gloves should be worn during installation to prevent crushing and cutting injuries.
- ⚠ Do not allow the streams of the shower touch sensitive body parts (such as your eyes). An adequate distance must be kept between the shower and you.
- ⚠ The shower may only be used for bathing, hygiene and body cleaning purposes.

## INSTALLATION INSTRUCTIONS

- / The premounted filter insert must be used to ensure a normal flow of the shower and to prevent dirt from entering through the pipes. Dirt entering can affect the function and/or lead to damages to the shower. Hansgrohe will not be held liable for this type of damage.

## TECHNICAL DATA

Operating pressure:	max. 0,6 MPa
Recommended operating pressure:	0,25 - 0,4 MPa (1 MPa = 10 bar = 147 PSI)
Hot water temperature:	max. 60°C
Thermal disinfection:	max. 70°C / 4 min

The product is exclusively designed for drinking water!

## INDICAZIONI SULLA SICUREZZA

- ⚠ Durante il montaggio, per evitare ferite da schiacciamento e da taglio bisogna indossare guanti protettivi.
- ⚠ Bisogna evitare il contatto fra il getto della doccia e parti del corpo delicate (ad es. gli occhi). Fra il soffione ed il corpo va mantenuta una distanza sufficiente.
- ⚠ La doccia deve essere impiegata solo per il bagno e utilizzo igienico e pulizia del corpo.

## ISTRUZIONI PER IL MONTAGGIO







- / L'inserto filtrante premontato deve essere utilizzato per garantire il flusso normale della doccia e per evitare risciacqui di sporczia dalla rete idrica. Risciacqui di sporczia possono pregiudicare la funzione e/o danneggiare parti funzionali della doccia. Per danni risultanti da ciò non risponde la Hansgrohe

## DATI TECNICI







Pressione d'uso:	max. 0,6 MPa
Pressione d'uso consigliata:	0,25 - 0,4 MPa (1 MPa = 10 bar = 147 PSI)
Temperatura dell'acqua calda:	max. 60°C
Disinfezione termica:	max. 70°C / 4 min

Il prodotto è concepito esclusivamente per acqua potabile!

## SYMBOL DESCRIPTION

-  DIMENSIONS (see page 18)
-  FLOW DIAGRAM (see page 18)
-  OPERATION (see page 17)
-  SPARE PARTS (see page 17)
-  CLEANING (see page 17) and enclosed brochure
-  TEST CERTIFICATE (see page 20)

## DESCRIZIONE SIMBOLO

-  INGOMBRI (vedi pagg. 18)
-  DIAGRAMMA FLUSSO (vedi pagg. 18)
-  PROCEDURA (vedi pagg. 17)
-  PARTI DI RICAMBIO (vedi pagg. 17)
-  PULITURA (vedi pagg. 17) e brochure allegata
-  SEGNO DI VERIFICA (vedi pagg. 20)

ASSEMBLY (see page 17) 

MONTAGGIO (vedi pagg. 17) 

## INDICACIONES DE SEGURIDAD

- ⚠ Durante el montaje deben utilizarse guantes para evitar heridas por aplastamiento o corte.
- ⚠ Debe evitarse el contacto del chorro del pulverizador con partes sensibles del cuerpo (por ej. ojos). Debe mantenerse una distancia suficiente entre pulverizador y cuerpo.
- ⚠ La roseta de ducha solo debe utilizarse para fines de baño, higiene y limpieza corporal.

## INDICACIONES PARA EL MONTAJE

- / El inserto de filtro premontado debe utilizarse para garantizar el caudal normado de la ducha manual y evitar que penetre suciedad procedente de la red de conducción. La suciedad puede limitar el funcionamiento y provocar daños en partes funcionales de la ducha manual. Hansgrohe no asumirá ninguna responsabilidad por los daños que de ello se deriven.

## DATOS TÉCNICOS

Presión en servicio:	max. 0,6 MPa
Presión recomendada en servicio:	0,25 - 0,4 MPa (1 MPa = 10 bar = 147 PSI)
Temperatura del agua caliente:	max. 60°C
Desinfección térmica:	max. 70°C/4 min

El producto ha sido concebido exclusivamente para agua potable.

## DESCRIPCIÓN DE SÍMBOLOS

-  DIMENSIONES (ver página 18)
-  DIAGRAMA DE CIRCULACIÓN (ver página 18)
-  MANEJO (ver página 17)
-  REPUESTOS (ver página 17)
-  LIMPIAR (ver página 17) y folleto anexo
-  MARCA DE VERIFICACIÓN (ver página 20)

MONTAJE (ver página 17) 

## VEILIGHEIDSIINSTRUCTIES

- ⚠ Bij de montage moeten ter voorkoming van knel- en snijwonden handschoenen worden gedragen.
- ⚠ Het contact van de douchestraal met gevoelige lichaamsdelen (bijv. ogen) moet worden voorkomen. Er moet voldoende afstand tussen douche en lichaam aangehouden worden.
- ⚠ De douche uitsluitend toepassen in badkamers ten behoeve van lichaamsreiniging.

## MONTAGE-INSTRUCTIES

- / Het voorgemonteerde filterelement moet gebruikt worden om het normdebiet van de handdouche te garanderen en om vuil uit de waterleiding te weren. Vuil uit de waterleiding kan de werking negatief beïnvloeden en/of de handdouche beschadigen; voor daaruit voortvloeiende schade is Hansgrohe niet aansprakelijk.

## TECHNISCHE GEGEVENS

Werkdruk: max.	max. 0,6 MPa
Aanbevolen werkdruk:	0,25 - 0,4 MPa (1 MPa = 10 bar = 147 PSI)
Temperatuur warm water:	max. 60°C
Thermische desinfectie:	max. 70°C/4 min

Het product is uitsluitend ontworpen voor drinkwater!

## SYMBOOLBESCHRIJVING

-  MATEN (zie blz. 18)
-  DOORSTROOMDIAGRAM (zie blz. 18)
-  BEDIENING (zie blz. 17)
-  SERVICE ONDERDELEN (zie blz. 17)
-  REINIGEN (zie blz. 17) en bijgevoegde brochure
-  KEURMERK (zie blz. 20)

MONTAGE (zie blz. 17) 

## SIKKERHEDSANVISNINGER

- ⚠ Ved monteringen skal der bruges handsker for at undgå kvæstelser og snitsår.
- ⚠ Bruserstrålen kontakt med sensitive områder (f.eks. øjne) skal undgås. Der skal være en tilstrækkelig afstand mellem bruseren og kroppen.
- ⚠ Bruseren må kun bruges til at bruse, til hygiejne og rengøring af kroppen.

## MONTERINGSANVISNINGER

- / For at garantere håndbruserens standardgennemstrømning og for at undgå tilsmudsninger fra ledningsnettet, skal man bruge den formonterede filterindsats. Tilsmudsningen kan påvirke funktionen og/eller føres til skader på håndbruserens funktionskomponenter. Hans Grohe er ikke ansvarligt for heraf resulterende skader

## TEKNISKE DATA

Driftstryk:	max. 0,6 MPa
Anbefalet driftstryk:	0,25 - 0,4 MPa (1 MPa = 10 bar = 147 PSI)
Varmtvandstemperatur:	max. 60°C
Termisk desinfektion:	max. 70°C / 4 min

Produktet er udelukkende beregnet til drikkevand!

## SYMBOLBESKRIVELSE

-  MÅLENE (se s. 18)
-  GENNEMSTRØMNINGSDIAGRAM (se s. 18)
-  BRUGSANVISNING (se s. 17)
-  RESERVEDELE (se s. 17)
-  RENGØRING (se s. 17) og vedlagt brochure
-  GODKENDELSE (se s. 20)

MONTERING (se s. 17) 

## AVISOS DE SEGURANÇA

- ⚠ Durante a montagem devem ser utilizadas luvas de protecção, de modo a evitar ferimentos resultantes de entalamentos e de cortes.
- ⚠ Deve-se evitar o contacto dos jactos de água com partes do corpo sensíveis (p. ex. olhos). É necessário manter uma distância suficiente entre o chuveiro e o corpo.
- ⚠ O chuveiro só pode ser utilizado para fins de higiene pessoal.

## AVISOS DE MONTAGEM







- / O elemento filtrante pré-montado tem que ser utilizado para garantir o fluxo normalizado do chuveiro de mão e para evitar a entrada de sujidade proveniente da rede. A sujidade proveniente da rede pode influenciar o funcionamento e/ou provocar danos nas peças funcionais do chuveiro de mão. A Hansgrohe não se responsabiliza por danos daí resultantes.

## DADOS TÉCNICOS

Pressão de funcionamento:	max. 0,6 MPa
Pressão de func. recomendada:	0,25 - 0,4 MPa (1 MPa = 10 bar = 147 PSI)
Temperatura da água quente:	max. 60°C
Desinfecção térmica:	max. 70°C / 4 min

Este produto foi única e exclusivamente concebido para água potável!

## DESCRIÇÃO DO SÍMBOLO

-  MEDIDAS (ver página 18)
-  FLUXOGRAMA (ver página 18)
-  FUNCIONAMENTO (ver página 17)
-  PEÇAS DE SUBSTITUIÇÃO (ver página 17)
-  LIMPEZA (ver página 17) e brochura em anexo
-  MARCA DE CONTROLO (ver página 20)

MONTAGEM (ver página 17) 

## WSKAZÓWKI BEZPIECZEŃSTWA

- ⚠ Aby uniknąć zranień na skutek zgniecenia lub przecięcia, podczas montażu należy nosić rękawice ochronne.
- ⚠ Należy unikać kontaktu strumienia wypyływającego z głowicy z wrażliwymi częściami ciała (np. oczami). Należy zachowywać odpowiednią odległość pomiędzy głowicą a ciałem.
- ⚠ Prysznic może być używany tylko do kąpieli, higieny i czyszczenia ciała.

## WSKAZÓWKI MONTAŻOWE

- / Należy użyć zamontowaną uprzednio wkładkę filtra, aby zapewnić przepisywany przepływ przez prysznic ręczny i zapobiec przedostawianiu się zanieczyszczeń z instalacji sieciowej. Przedostające się zanieczyszczenia mogą mieć negatywny wpływ na działanie i/lub prowadzić do usterek w działaniu elementów prysznica ręcznego; za powstałe z tego tytułu szkody firma Hansgrohe nie ponosi odpowiedzialności.

## DANE TECHNICZNE

Ciśnienie robocze:	maks. 0,6 MPa
Zalecane ciśnienie robocze:	0,25 - 0,4 MPa (1 MPa = 10 bary = 147 PSI)
Temperatura wody gorącej:	maks. 60°C
Dezynfekcja termiczna:	maks. 70°C / 4 min

Produkt przeznaczony wyłącznie do wody pitnej!

## OPIS SYMBOLU

-  WYMIARY (patrz strona 18)
-  SCHEMAT PRZEPŁYWU (patrz strona 18)
-  OBSŁUGA (patrz strona 17)
-  CZĘŚCI SERWISOWE (patrz strona 17)
-  CZYSZCZENIE (patrz strona 17) i dołączona broszura
-  ZNAK JAKOŚCI (patrz strona 20)

MONTAŻ (patrz strona 17) 

## BEZPEČNOSTNÍ POKYNY

- ⚠ Pro zabránění řezným zraněním a pohmožděninám je nutné při montáži nosit rukavice.
- ⚠ Je nutné zabránit kontaktu vodních paprsků sprchy s měkkými částmi těla (např. očima). Je nutné dodržovat dostatečný odstup mezi sprchou a tělem.
- ⚠ Sprcha smí být používána pouze za účelem koupání a tělesné hygieny.

## POKYNY K MONTÁŽI

- / Pro zaručení normálního průtoku ruční sprchy a zabránění vzniku usazenin z přírodního vedení se musí použít předmontovaná filtrační vložka. Usazeniny nečistot mohou ovlivnit funkci sprchy a/nebo vést k poškození funkčních dílů sprchy. Za takto vzniklé škody firma Hansgrohe neručí.

## TECHNICKÉ ÚDAJE

Provozní tlak:	max. 0,6 MPa
Doporučený provozní tlak:	0,25 - 0,4 MPa (1 MPa = 10 bar = 147 PSI)
Teplota horké vody:	max. 60°C
Teplná desinfekce:	max. 70°C / 4 min

Výrobky Hansgrohe jsou vhodné pro přímý kontakt s pitnou vodou.

## POPIS SYMBOLŮ

-  ROZMĚRY (viz strana 18)
-  DIAGRAM PRŮTOKU (viz strana 18)
-  OVLÁDÁNÍ (viz strana 17)
-  SERVISNÍ DÍLY (viz strana 17)
-  ČIŠTĚNÍ (viz strana 17) a příložená brožura
-  ZKUŠEBNÍ ZNAČKA (viz strana 20)

MONTÁŽ (viz strana 17) 

## BEZPEČNOSTNÉ POKYNY

- △ Pri montáži musíte nosiť rukavice, aby ste predišli pomliaždeninám a rezným poraneniam.
- △ Vyhýbajte sa kontaktu vodného lúča sprchy s citlivými miestami tela (napr. oči). Dodržiavajte dostatočnú vzdialenosť medzi sprchou a telom.
- △ Sprcha sa smie používať len na účely kúpania a telesnej hygieny.

## POKYNY PRE MONTÁŽ

- / Predmontovaná filtračná vložka sa musí použiť, aby sa zaručil normovaný prietok ručnej sprchy a odstránili naplaveniny nečistôt z rozvodnej siete. Naplaveniny nečistôt môžu ovplyvniť funkčnosť a/alebo môžu viesť k poškodeniam funkčných dielov ručnej sprchy, pričom za takto spôsobené škody spoločnosť Hansgrohe neručí.

## TECHNICKÉ ÚDAJE

Prevádzkový tlak:	max. 0,6 MPa
Doporučený prevádzkový tlak:	0,25 - 0,4 MPa (1 MPa = 10 bar = 147 PSI)
Teplota teplej vody:	max. 60°C
Termická dezinfekcia:	max. 70°C / 4 min

Výrobok je koncipovaný výhradne pre pitnú vodu!

## POPIS SYMBOLOV

-  ROZMERY (viď strana 18)
-  DIAGRAM PRIETOKU (viď strana 18)
-  OBSLUHA (viď strana 17)
-  SERVISNÉ DIELY (viď strana 17)
-  ČISTENIE (viď strana 17) a priložená brožúra
-  OSVEDČENIE O SKÚŠKE (viď strana 20)

MONTÁŽ (viď strana 17) 

## 安全技巧

- △ 装配时为避免挤压和切割受伤，必须戴上手套。
- △ 必须避免让身体敏感部位（如眼睛）接触到莲蓬头喷水。必须保持莲蓬头与人头之间有足够的距离。
- △ 该莲蓬头仅允许作淋浴、卫生保健和身体清洁目的使用。

## 安装提示

- / 必须使用预装配好的过滤器芯，以保障手持花洒达到标准水流量并避免从管网中冲出污物。污物可损害功能和/或导致损坏手持花洒的功能件，由此所产生的损害汉斯格雅公司将不承担责任。

## 技术参数

工作压力:	最大 0,6 MPa
推荐工作压力:	0,25 - 0,4 MPa (1 MPa = 10 bar = 147 PSI)
热水温度:	最大 60°C
热力消毒:	最大 70°C / 4 分钟



该产品专为饮用水设计！

## 符号说明

-  大小 (参见第 18 页)
-  流量示意图 (参见第 18 页)
-  操作 (参见第 17 页)
-  备用零件 (参见第 17 页)
-  清洗 (参见第 17 页) 并附有小手册
-  检验标记 (参见第 20 页)

安装 (参见第 17 页) 

## УКАЗАНИЯ ПО ТЕХНИКЕ БЕЗОПАСНОСТИ

-  Во время монтажа следует надеть перчатки во избежание прищемления и порезов.
-  Не допускайте попадания струи воды из разбрызгивателя на чувствительные части тела (например, на глаза). Разбрызгиватель следует устанавливать на достаточном расстоянии от тела.
-  Источник разбрызгивания разрешается использовать только в гигиенических целях для принятия ванны и личной гигиены.

## УКАЗАНИЯ ПО МОНТАЖУ

- / Необходимо установить предварительно смонтированный фильтрующий элемент, чтобы обеспечить нормальный поток для ручного душа и предотвратить попадание загрязнений из канализационной сети. Попадание загрязнений ухудшает работу и/или приводит к повреждению функциональных деталей ручного душа. Компания Hansgrohe не несет ответственности за ущерб, причиненный в результате несоблюдения этого требования

## ТЕХНИЧЕСКИЕ ДАННЫЕ

Рабочее давление: не более. 0,6 МПа  
 Рекомендуемое рабочее давление: 0,25 - 0,4 МПа  
 (1 МПа = 10 bar = 147 PSI)  
 Температура горячей воды: не более. 60°C  
 Термическая дезинфекция: не более. 70°C/4 мин  
 Изделие предназначено исключительно для питьевой воды!

## ОПИСАНИЕ СИМВОЛОВ

 РАЗМЕРЫ (см. стр. 18)

 СХЕМА ПОТОКА  
(см. стр. 18)



 ЭКСПЛУАТАЦИЯ (см. стр. 17)

 КОМПЛЕКТ (см. стр. 17)

 ОЧИСТКА (см. стр. 17) и прилагаемая брошюра

 ЗНАК ТЕХНИЧЕСКОГО КОНТРОЛЯ (см. стр. 20)

## BIZTONSÁGI UTASÍTÁSOK

-  A szerelésnél a zúzódások és vágási sérülések elkerülése érdekében kesztyűt kell viselni.
-  Kerülni kell a zuhanyugár érintkezését érzékeny testrészekkel (pl. szemek). Be kell tartani a megfelelő távolságot a zuhanyfej és a test között.
-  A zuhanyt csak fürdő- higiéniai- és tisztítási célra szabad használni.

## SZERELÉSI UTASÍTÁSOK

- / Az előre felszerelt szűrőbetétet kell használni a kézi zuhany szabvány átfolyásának biztosításához, és hogy elkerülje a szennyeződések befolyását a vezetékből. A szennyeződések befolyásolhatják a működést és/vagy a kézi zuhany működő részeinek rongálódásához vezethetnek, az ebből származó károkkért a Hansgrohe nem vállal felelőséget

## MŰSZAKI ADATOK

Üzemi nyomás: max. 0,6 MPa  
 Ajánlott üzemi nyomás: 0,25 - 0,4 MPa  
 (1 MPa = 10 bar = 147 PSI)  
 Forróvíz hőmérséklet: max. 60°C  
 Termikus fertőtlenítés: max. 70°C/4 perc

A terméket kizárólag ivóvízhez tervezték!

## SZIMBÓLUMOK LEÍRÁSA

 MÉRETET (lásd a oldalon 18)

 ÁTFOLYÁSI DIAGRAMM  
(lásd a oldalon 18)

 HASZNÁLAT (lásd a oldalon 17)

 TARTOZÉKOK (lásd a oldalon 17)

 TISZTÍTÁS (lásd a oldalon 17) és mellékelt brossúrával

 VIZSGAJEL (lásd a oldalon 20)

МОНТАЖ (см. стр. 17) 

SZERELÉS (lásd a oldalon 17) 



## TURVALLISUUSOHJEET

- △ Asennuksessa on käytettävä käsineitä puristumien ja viiltojen aiheuttamien tapaturmien estämiseksi.
- △ Suihkuveden kontaktaia herkkien ruumiinosien (esim. silmien) kanssa on vältettävä. Suihkun ja vartalon välissä on oltava riittävä väli.
- △ Suihkua saa käyttää vain kylpy-, hygieniä ja kehonpuhdistustarkoituksiin.

## ASENNUSOHJEET

- / Esiasennettua suodatinpatruunaa on käytettävä, jotta käsिसuihkun normaali läpivirtaus on taattu ja likahiukkaskertymät voivat aiheuttaa toimintahäiriöitä ja/tai vahingoittaa käsिसuihkun toiminnallisia osia, Hansgrohe ei vastaa näin syntyvistä vaurioista.

## TEKNISET TIEDOT

Käyttöpain:	maks. 0,6 MPa
Suosittelut käyttöpain:	0,25 - 0,4 MPa (1 MPa = 10 bar = 147 PSI)
Kuuman veden lämpötila:	maks. 60°C
Lämpödesinfektio:	maks. 70°C/4 min

Tuote on suunniteltu käytettäväksi ainoastaan juomaveden kanssa!

## MERKIN KUVAUS

-  MITAT (katso sivu 18)
-  VIRTAUSDIAGRAMMI (katso sivu 18)
-  KÄYTTÖ (katso sivu 17)
-  VARAOSAT (katso sivu 17)
-  PUHDISTUS (katso sivu 17) ja oheinen esite
-  KOESTUSMERKKI (katso sivu 20)

ASENNUS (katso sivu 17) 

## SÄKERHETSANVISNINGAR

- △ Handskar ska bäras under monteringsarbetet så att man kan undvika kläm- och skärskadorgen werden.
- △ Undvik att rikta duschstrålarna mot känsliga kroppsdelar (t. ex. ögonen). Det måste finnas ett tillräckligt stort avstånd mellan duschen och kroppen.
- △ Duschen får bar användas till dusch-, bad- och personlig hygien.

## MONTERINGSANVISNINGAR

- / Den förmonterade filterinsatsen måste användas om normalflödet hos handduschen ska vara garanterat och för att undvika att smuts spolans in från ledningsnätet. Smuts som spolans in kan påverka funktionen och/eller leda till skador på funktionsdelar i handduschen. Hansgrohe fränsäger sig allt ansvar för skador som kan härledas till detta.

## TEKNISKA DATA

Driftstryck:	max. 0,6 MPa
Rek. driftstryck:	0,25 - 0,4 MPa (1 MPa = 10 bar = 147 PSI)
Varmvattentemperatur:	max. 60°C
Termisk desinfektion:	max. 70°C/4 min

Produkten är enbart avsedd för dricksvatten!

## SYMBOLFÖRKLARING

-  MÅTTEN (se sidan 18)
-  FLÖDESSCHEMA (se sidan 18)
-  HANTERING (se sidan 17)
-  RESERVDELAR (se sidan 17)
-  RENGÖRING (se sidan 17) och medföljande broschyr
-  TESTSIGILL (se sidan 20)

MONTERING (se sidan 17) 

## SAUGUMO TECHNIKOS NURODYMAI

- ⚠ Apsaugai nuo užspaudimo ir įsijovimo montavimo metu mūvėkite pirštines.
- ⚠ Būtina vengti dušo vandens srovės kontakto su jautriomis kūno vietomis (pvz., akimis). Todėl būtina laikytis tinkamo atstumo nuo dušo.
- ⚠ Dušo galva naudojama tik maudymosi, higieniniais ir kūno švarinimo tikslais.

## MONTAVIMO INSTRUKCIJA







- / Reikia naudoti sumontuotą filtro elementą, kad būtų užtikrintas norminis per rankinį dušą pratekantis srautas ir būtų išvengta teršalų, galinčių patekti iš vamzdyno. Patekę teršalai gali pakenkti veikimui ir/arba sugadinti veikiančias dalis. Už žalą, atsiradusį dėl šių priežasčių, bendrovė „Hansgrohe“ neatsako.

## TECHNINIAI DUOMENYS

Darbinis slėgis: ne daugiau kaip 0,6 MPa  
 Rekomenduojamas slėgis: 0,25 - 0,4 MPa  
 (1 MPa = 10 barų = 147 PSI)  
 Karšto vandens temperatūra: ne daugiau kaip 60°C  
 Terminis dezinfekavimas: ne daugiau kaip 70°C / 4 min

Produktas skirtas tik geriamajam vandeniui!

## SIMBOLIO APRAŠYMAS

-  IŠMATAVIMAI (žr. psl. 18)
-  PRALAUDIMO DIAGRAMA (žr. psl. 18)
-  EKSPLOATACIJA (žr. psl. 17)
-  ATSARGINĖS DALYS (žr. psl. 17)
-  VALYMAS (žr. psl. 17) ir pridėdama brošiūra
-  BANDYMO PAŽYMA (žr. psl. 20)

MONTAVIMAS (žr. psl. 17) 

## SIGURNOSNE UPUTE

- ⚠ Prilikom montaže se radi sprječavanja prignječenja i posjekotina moraju nositi rukavice.
- ⚠ Mora se izbjegavati kontakti mlaza iz tuša s osjetljivim dijelovima tijela (npr. očima). Tijelo korisnika mora biti dovoljno udaljeno od tuša.
- ⚠ Tuš se smije primjenjivati samo za kupanje, tuširanje i osobnu higijenu.

## UPUTE ZA MONTAŽU

- / Mora se rabiti predmontirani filtarski umetak, kako bi se regulirao protok vode kroz ručni tuš i izbjeglo unošenje prljavštine iz vodovoda. Prljavština može dovesti do djelomičnog ili potpunog oštećenja dijelova ručnog tuša. Za eventualna oštećenja uzrokovana prljavštinom proizvođač Hansgrohe nije odgovoran.

## TEHNIČKI PODATCI

Najveći dopušteni tlak: tlak 0,6 MPa  
 Preporučeni tlak: 0,25 - 0,4 MPa  
 (1 MPa = 10 bar = 147 PSI)  
 Temperatura vruće vode: tlak 60°C  
 Termička dezinfekcija: tlak 70°C / 4 min

Proizvod je koncipiran isključivo za pitku vodu!

## OPIS SIMBOLA

-  MJERE (pogledaj stranicu 18)
-  DIJAGRAM PROTOKA (pogledaj stranicu 18)
-  UPOTREBA (pogledaj stranicu 17)
-  REZERVNI DJELOVI (pogledaj stranicu 17)
-  ČIŠĆENJE (pogledaj stranicu 17) i priložena brošura
-  OZNAKA TESTIRANJA (pogledaj stranicu 20)

SASTAVLJANJE (pogledaj stranicu 17) 

## GÜVENLİK UYARILARI

- ⚠ Montaj esnasında ezilme ve kesilme gibi yaralanmaları önlemek için eldiven kullanılmalıdır.
- ⚠ Püskürtme başlıklarının hassas organlara teması (örn. gözler) önlenmelidir. Püskürtücü ile beden arasında yeterli mesafe bırakılmalıdır.
- ⚠ Su püskürtücü yalnızca banyo, hijyen ve yıkanma amaçları için kullanılabilir.

## MONTAJ AÇIKLAMALARI

- / Ön montajı yapılan filtre elemanı, el püskürtücüsünün standart akışını sağlamak ve hat şebekesindeki kirlenmeleri önlemek için kullanılmalıdır. Kirlenmeler işlevi olumsuz etkileyebilir ve/veya el püskürtücüsünün işlev parçalarında hasarlara yol açabilir. Hansgrohe, bundan dolayı kaynaklanabilecek hasarlara karşı sorumluluk üstlenmez.

## TEKNİK BİLGİLER

İşletme basıncı:	azami 0,6 MPa
Tavsiye edilen işletme basıncı:	0,25 - 0,4 MPa (1 MPa = 10 bar = 147 PSI)
Sıcak su sıcaklığı:	azami 60°C
Termik dezenfeksiyon:	azami 70°C/4 dak

Ürün sadece şebeke suyu için tasarlanmıştır!

## INSTRUCȚIUNI DE SIGURANȚĂ

- ⚠ La montare utilizați mănuși pentru evitarea contuziunilor și tăierii mâinilor.
- ⚠ Evitați contactul jetului de apă cu părțile de corp sensibile (de ex. ochii). Țineți dușul la o distanță corespunzătoare de corp.
- ⚠ Dușul poate fi utilizat doar în scopuri de spălare, igienizare și de întreținere a igienei corporale.

## INSTRUCȚIUNI DE MONTARE

- / Cartușul de filtru premontat se va utiliza pentru asigurarea debitului normal al telefonului de duș și pentru evitarea penetrării impurităților din rețeaua de apă. Aceste impurități pot afecta funcționarea dușului și/sau pot cauza deteriorarea elementelor funcționale ale telefonului de duș, firma Hansgrohe nu-și asumă răspunderea pentru daunele cauzate de aceste impurități

## DATE TEHNICE

Presiune de funcționare:	max. 0,6 MPa
Presiune de funcționare recomandată:	0,25 - 0,4 MPa (1 MPa = 10 bar = 147 PSI)
Temperatura apei calde:	max. 60°C
Dezinfecție termică:	max. 70°C/4 min

Produsul este destinat exclusiv pentru apă potabilă.

## SİMGE AÇIKLAMASI

-  ÖLÇÜLERİ (bakınız sayfa 18)
-  AKIŞ DİYAGRAMI (bakınız sayfa 18)
-  KULLANIMI (bakınız sayfa 17)
-  YEDEK PARÇALAR (bakınız sayfa 17)
-  TEMİZLEME (bakınız sayfa 17) ve birlikte verilen broşür
-  KONTROL İŞARETİ (bakınız sayfa 20)

## DESCRIEREA SIMBOLURILOR

-  DIMENSIUNI (vezi pag. 18)
-  DIAGRAMA DE DEBIT (vezi pag. 18)
-  UTILIZARE (vezi pag. 17)
-  PIESE DE SCHIMB (vezi pag. 17)
-  CURĂȚARE (vezi pag. 17) și broșura alăturată
-  CERTIFICAT DE TESTARE (vezi pag. 20)

MONTAJI (bakınız sayfa 17) 

MONTARE (vezi pag. 17) 

## ΥΠΟΔΕΙΞΕΙΣ ΑΣΦΑΛΕΙΑΣ

- ⚠ Για να αποφύγετε τραυματισμούς κατά τη συναρμολόγησή πρέπει να φοράτε γάντια.
- ⚠ Η επαφή δέσμης νερού του ντους με ευαίσθητες περιοχές του σώματος (π.χ. μάτια) πρέπει να αποφεύγεται. Διατηρείτε επαρκή απόσταση ανάμεσα στο ντους και το σώμα.
- ⚠ Το ντους επιτρέπεται να χρησιμοποιείται μόνο για το μπάνιο, τον καθαρισμό και την υγιεινή του σώματος.

## ΟΔΗΓΙΕΣ ΣΥΝΑΡΜΟΛΟΓΗΣΗΣ







- / Το τοποθετημένο στοιχείο φίλτρου πρέπει να χρησιμοποιηθεί, για να διασφαλιστεί η αναγκαία ροή νερού του τηλεφώνου του ντους και να αποφευχθεί η εκροή ακαθαρσιών από το δίκτυο παροχής ύδατος. Η εκροή ακαθαρσιών μπορεί να επηρεάσει τη λειτουργία και/ή να προκαλέσει ζημιές σε λειτουργικά μέρη του τηλεφώνου του ντους, για τις οποίες η Hansgrohe δεν ευθύνεται.

## ΤΕΧΝΙΚΑ ΧΑΡΑΚΤΗΡΙΣΤΙΚΑ

Λειτουργία πίεσης:	έως 0,6 MPa
Συνιστώμενη λειτουργία πίεσης:	0,25 - 0,4 MPa (1 MPa = 10 bar = 147 PSI)
Θερμοκρασία ζεστού νερού:	έως 60°C
Θερμική απολύμανση:	έως 70°C/4 min

Το προϊόν έχει σχεδιαστεί αποκλειστικά για πόσιμο νερό!

## ΠΕΡΙΓΡΑΦΗ ΣΥΜΒΟΛΩΝ

-  ΔΙΑΣΤΑΣΕΙΣ (βλ. Σελίδα 18)
-  ΔΙΑΓΡΑΜΜΑ ΡΟΗΣ (βλ. Σελίδα 18)
-  ΧΕΙΡΙΣΜΟΣ (βλ. Σελίδα 17)
-  ΑΝΤΑΛΛΑΚΤΙΚΑ (βλ. Σελίδα 17)
-  ΚΑΘΑΡΙΣΜΟΣ (βλ. Σελίδα 17) και συννημένο φυλλάδιο
-  ΣΗΜΑ ΕΛΕΓΧΟΥ (βλ. Σελίδα 20)

ΣΥΝΑΡΜΟΛΟΓΗΣΗ (βλ. Σελίδα 17) 

## VARNOSTNA OPOZORILA

- ⚠ Pri montaži je treba nositi rokavice, da se preprečijo poškodbe zaradi zmečkanja ali urezov.
- ⚠ Izogibati se je treba stiku prhalnega curka z občutljivimi deli telesa (npr. očmi). Med telesom in prho mora biti vedno zadosten razmik.
- ⚠ Prha se sme uporabljati le z namenom vzdrževanja higiene oziroma umivanja kopalnice in telesa.

## NAVODILA ZA MONTAŽO

- / Za zagotovitev standardiziranega pretoka ročne prhe in za preprečevanje vtoka umazanije iz vodovodnega omrežja se mora uporabiti predmontiran filtrski vložek. Vtok umazanije lahko poslabša delovanje ročne prhe in/ali pripelje do poškodovanja njenih funkcionalnih delov. Za tako nastalo škodo podj. Hansgrohe ne odgovarja

## TEHNIČNI PODATKI

Delovni tlak:	maks. 0,6 MPa
Priporočeni delovni tlak:	0,25 - 0,4 MPa (1 MPa = 10 bar = 147 PSI)
Temperatura tople vode:	maks. 60°C
Termična dezinfekcija:	maks. 70°C/4 min

Proizvod je zasnovan izključno za sanitarno vodo!

## OPIS SIMBOLA

-  MERE (glejte stran 18)
-  DIAGRAM PRETOKA (glejte stran 18)
-  UPRAVLJANJE (glejte stran 17)
-  REZERVNI DELI (glejte stran 17)
-  ČIŠČENJE (glejte stran 17) in priložena brošura
-  PRESKUSNI ZNAK (glejte stran 20)

MONTAŽA (glejte stran 17) 

## OHUTUSJUHISED

- ⚠ Kandke paigaldamisel muljumis- ja löikevigastuste vältimiseks kindaid.
- ⚠ Duši veejoad ei tohi kokku puutuda tundlike kehaosadega (nt silmad). Jätke duši ja keha vahele piisav vahe.
- ⚠ Dušši tohib kasutada ainult vanniskäimiseks, hügieeniks ja keha pesemiseks.

## PAIGALDAMISJUHISED

- / Käsiduši normaalse läbivoolu tagamiseks ja torustikut pärit mustuse vältimiseks tuleb kasutada eelmonteeritud filtrit. Mustus võib talitlust halvendada ja/või tekitada käsiduši talitlusesadel kahjustusi, mille korral Hansgrohe ei vastuta.

## TEHNILISED ANDMED

Töörõhk	maks. 0,6 MPa
Soovitatav töörõhk:	0,25 - 0,4 MPa (1 MPa = 10 baari = 147 PSI)
Kuuma vee temperatuur:	maks. 60°C
Termiline desinfitatsioon:	maks. 70°C / 4 min

Toode on ette nähtud eranditult joogivee jaoks!

## DROŠĪBAS NORĀDES

- ⚠ Montāžas laikā, lai izvairītos no saspiedumiem un iegriezumiem, nepieciešams nēsāt cimdus.
- ⚠ Nepieciešams izvairīties no dušas strūkļas tieša kontakta ar jutīgām ķermeņa daļām (piem., acīm). Nepieciešams ievērot pietiekošu attālumu starp dušu un ķermeni.
- ⚠ Dušu drīkst izmantot vienīgi vannošānās, higiēnas un ķermeņa tīrīšanas nolūkiem.

## NORĀDĪJUMI MONTĀŽAI







- / Iepriekš iemontētais filtra elements ir jāizmanto, lai nodrošinātu normālu plūsmu dušas sprauslās un izvairītos no netīrumu ieplūšanas no ūdensvada. Netīrumu ieplūšana var ietekmēt funkciju un/vai radīt bojājumus dušas sprauslas elementos, par šādiem bojājumiem Hansgrohe neatbild.

## TEHNISKIE DATI

Darba spiediens:	maks. 0,6 MPa
Ieteicamais darba spiediens:	0,25 - 0,4 MPa (1 MPa = 10 bar = 147 PSI)
Karstā ūdens temperatūra:	maks. 60°C
Termiskā dezinfekcija :	maks. 70°C / 4 min

Izstrādājums ir paredzēts tikai dzeramajam ūdenim!

## SŪMBOLITE KIRJELDUS

-  MĒŪTUDE (vt lk 18)
-  LĀBIVOOLUDIAGRAMM (vt lk 18)
-  KASUTAMINE (vt lk 17)
-  VARUOSAD (vt lk 17)
-  PUHASTAMINE (vt lk 17) ja kaasas-olev brošūūr
-  KONTRĒLLSERTIFIKĀAT (vt lk 20)

## SIMBĒLU NOZĪME

-  IZMĒRUS (skat. lpp. 18)
-  CAURPLŪDES DIAGRAMMA (skat. lpp. 18)
-  LIETOŠANA (skat. lpp. 17)
-  REZERVES DAĻĀS (skat. lpp. 17)
-  TĪRĪŠANA (skat. lpp. 17) un klāt pievienotais buklets
-  PĀRBAUDES ZĪME (skat. lpp. 20)

PAIGALDAMINE (vt lk 17) 

MONTĀŽA (skat. lpp. 17) 

## SIGURNOSNE NAPOMENE

- ⚠ Prilikom montaže se radi sprečavanja prignječenja i posekotine moraju nositi rukavice.
- ⚠ Mora se izbegavati kontakt mlaza iz tuša sa osetljivim delovima tela (npr. očima). Telo korisnika mora biti na dovoljnom odstojanju od tuša.
- ⚠ Tuš sme da se koristi samo za kupanje, tuširanje i ličnu higijenu.

## INSTRUKCIJE ZA MONTAŽU

- / Mora se koristiti predmontirani filterski uložak, kako bi se regulisao protok vode kroz ručni tuš i izbeglo prodiranje prljavštine iz vodovoda. Prljavština može dovesti do delimičnog ili potpunog oštećenja delova ručnog tuša. Za eventualna oštećenja prouzrokovana prljavštinom proizvođač Hansgrohe nije odgovoran.

## TEHNIČKI PODACI

Radni pritisak:	maks. 0,6 MPa
Preporučeni radni pritisak:	0,25 - 0,4 MPa (1 MPa = 10 bar = 147 PSI)
Temperatura vruće vode:	maks. 60°C
Termička dezinfekcija:	maks. 70°C/4 min

Proizvod je koncipiran isključivo za pijaću vodu!

## OPIS SIMBOLA

-  MERE (vidi stranu 18)
-  DIJAGRAM PROTOKA (vidi stranu 18)
-  RUKOVANJE (vidi stranu 17)
-  REZERVNI DELOVI (vidi stranu 17)
-  ČIŠĆENJE (vidi stranu 17) i priložena brošura
-  ISPITNI ZNAK (vidi stranu 20)

MONTAŽA (vidi stranu 17) 

## SIKKERHETSHENVISNINGER

- ⚠ Bruk hansker under montasjen for å unngå klem- og kuttskader.
- ⚠ Dusjstrålen skal ikke komme i kontakt med ømfintlige kroppsdeler (f.eks. øynene). Overhold en tilstrekkelig avstand mellom dusjen og kroppen.
- ⚠ Dusjen skal kun brukes for bading, til hygieneformål og til kropprensing.

## MONTAGEHENVISNINGER

- / Den forhåndsmonterte filterinnsatsen skal brukes for å garantere hånddusjens standardgjennomstrømning og for å forhindre smussinnspylinger fra ledningsnett. Smussinnspylinger kan påvirke funksjonen negativt og/eller føre til skader på hånddusjens funksjonsdeler. Hansgrohe påtar seg inget ansvar for skader som resulteres av dette.

## TEKNISKE DATA

Driftstrykk:	maks. 0,6 MPa
Anbefalt driftstrykk:	0,25 - 0,4 MPa (1 MPa = 10 bar = 147 PSI)
Varmtvannstemperatur	maks. 60°C
Termisk desinfisering:	maks. 70°C/4 min

Produktet er utelukkende designet for drikkevann!

## SYMBOLBESKRIVELSE

-  MÅL (se side 18)
-  GJENNOMSTRØMNINGSDIAGRAM (se side 18)
-  BETJENING (se side 17)
-  SERVICEDELER (se side 17)
-  RENGJØRING (se side 17) og vedlagt brosjyre
-  PRØVEMERKE (se side 20)

MONTASJE (se side 17) 

## УКАЗАНИЯ ЗА БЕЗОПАСНОСТ

- ⚠ При монтажа трябва да се носят ръкавици, за да се избегнат наранявания поради притискане или порязване.
- ⚠ Трябва да се избягва контакта на струите на разпръсквателя с чувствителни части на тялото (напр. очите). Между разпръсквателя и тялото трябва да се спазва достатъчно разстояние.
- ⚠ Позволено е използването на разпръсквателя само за къпане, хигиена и цели на почистване на тялото.

## УКАЗАНИЯ ЗА МОНТАЖ







- / Предварително монтираната филтърна вложка трябва да се използва, за да се осигури нормалния поток към ръчния разпръсквател и да се избегне натрупване на замърсявания от водопроводната мрежа. Натрупването на замърсявания може да наруши функцията и/или да доведе до увреждания на функционалните части на ръчния разпръсквател, Hansgrohe не носи отговорност за получените се по този начин щети

## ТЕХНИЧЕСКИ ДАННИ

Работно налягане:	макс. 0,6 МПа
Препоръчително работно налягане:	0,25 - 0,4 МПа (1 МПа = 10 bar = 147 PSI)
Температура на горещата вода:	макс. 60°C
Термична дезинфекция:	макс. 70°C/4 мин

Продуктът е разработен само за питейна вода!

## ОПИСАНИЕ НА СИМВОЛИТЕ

-  РАЗМЕРИ (вижте стр. 18)
-  ДИАГРАМА НА ПОТОКА (вижте стр. 18)
-  ОБСЛУЖВАНЕ (вижте стр. 17)
-  СЕРВИЗНИ ЧАСТИ (вижте стр. 17)
-  ПОЧИСТВАНЕ (вижте стр. 17) и приложена брошура
-  КОНТРОЛЕН ЗНАК (вижте стр. 20)

## UDHËZIME SIGURIE

- ⚠ Пër të evituar lëndimet e pickimeve ose të prerjeve gjatë procesit të montimit duhet që të vishni doreza.
- ⚠ Kontakti i valëve të dushit me pjesët e ndjeshme të trupit (p.sh. me sytë) duhet që të shmangët. Midis dushit dhe trupit duhet që të mbahet një distancë e mjaftueshme.
- ⚠ Dushi duhet të përdoret vetëm për qëllimet e banjave, të higjienës dhe të larjes së trupit.

## UDHËZIME PËR MONTIMIN

- / Njësia e montuar e filtrit duhet përdorur për të garantuar një rendiment rrjedhjeje të spërkatëses së dorës në bazë të normës si dhe për të evituar thithjen e papastërtive nga rrjeti i ujësllësit. Ndotjet mund të ndikojnë në mënyrë negative në dhe mund të dëmtojnë pjesët funksionale të spërkatëses së dorës. Hansgrohe nuk mban përgjegjësi për dëmet e shkaktuara në këtë mënyrë.

## TË DHËNA TEKNIKE

Presioni gjatë punës	макс. 0,6 МПа
Presioni i rekomanduar:	0,25 - 0,4 МПа (1 МПа = 10 bar = 147 PSI)
Температура e ujit të ngrohtë	макс. 60°C
Dezinfektim Termik:	макс. 70°C/4 min

Produkti është projektuar ekskluzivisht për ujë të pijshëm!

## PËRSHKRIMI I SIMBOLIT

-  PËRMASAT (shih faqen 18)
-  DIAGRAMI I QARKULLIMIT (shih faqen 18)
-  PËRDORIMI (shih faqen 17)
-  PJESËT E SERVISIT (shih faqen 17)
-  PASTRIMI (shih faqen 17) dhe broshura bashkëngjitur
-  SHENJA E KONTROLLIT (shih faqen 20)

МОНТАЖ (вижте стр. 17) 

МОНТИМИ (shih faqen 17) 

## تنبيهات الأمان

⚠ يجب إرتداء قفازات لليد أثناء التركيب لتجنب حدوث أخطار الإنحشار أو الجروح.

⚠ يجب تجنب حدوث إتصال مباشر بين الماء الخارج من رأس الدش وبين أجزاء الجسم الحساسة (مثل العينين). يجب وجود مسافة كافية بين رأس الدش والجسم.

⚠ يسمح باستخدام الدش فقط لأغراض الإستحمام، والأغراض الصحية، وتنظيف الجسم.

## تعليمات التركيب

/ يجب استخدام وحدة الفلتر التي تم تركيبها مسبقاً لضمان التدفق الطبيعي من الرشاش اليدوي ومن أجل تجنب تسرب الأوساخ من شبكة الأنابيب الرئيسية، حيث يمكن لتسرب الأوساخ أن يتسبب في الإضرار بوظيفة الرشاش بشكل كلي أو جزئي أو كليهما. وبالتالي فإن شركة هانز جروهه (Hansgrohe) لن تتحمل مسؤولية أية أضرار ناتجة عن ذلك.

## المواصفات الفنية

ضغط التشغيل: الحد الأقصى 0,6 ميجاباسكال

ضغط التشغيل الموصى به: 0,25 - 0,4 ميجاباسكال

(1 ميجاباسكال = 10 بار = 147 PSI)

درجة حرارة الماء الساخن: الحد الأقصى 60°C

تعقيم حراري: الحد الأقصى 4/70°C الدقيقة

المنتج مخصص فقط لماء الشرب!

## وصف الرمز

أبعاد (راجع صفحة 18) 

رسم للصرف (راجع صفحة 18) 

التشغيل (راجع صفحة 17) 

قطع الغيار (راجع صفحة 17) 

التنظيف (راجع صفحة 17) والكتيب المرفق 

شهادة اختبار (راجع صفحة 20) 

التركيب (راجع صفحة 17) 



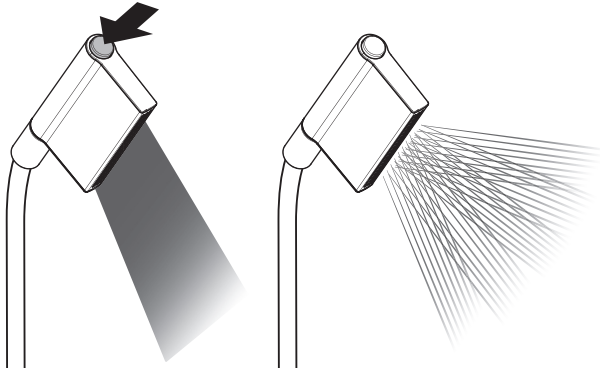
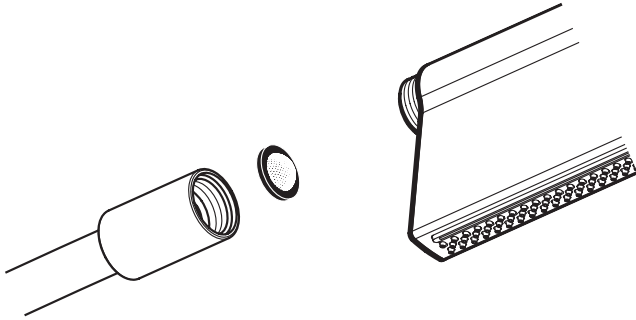

94246000

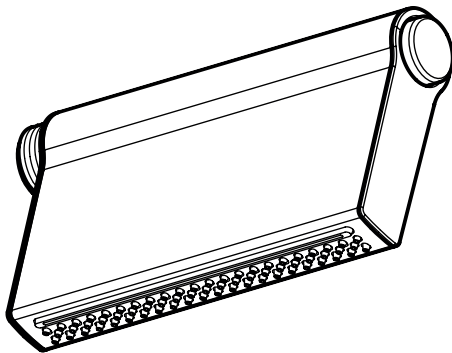



AXOR ONE  
45720000

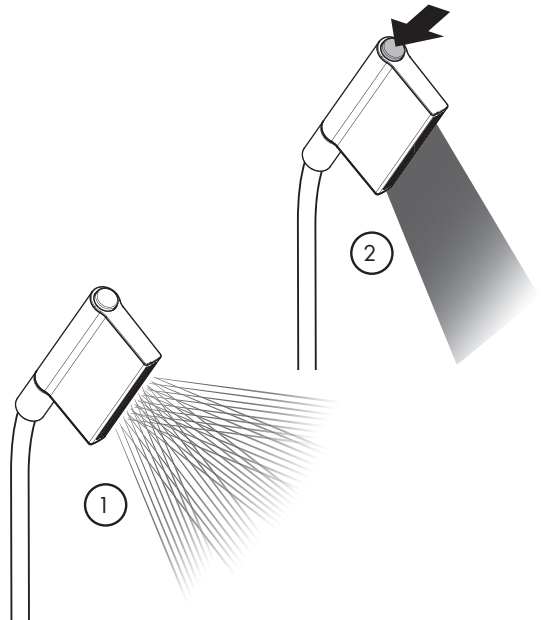
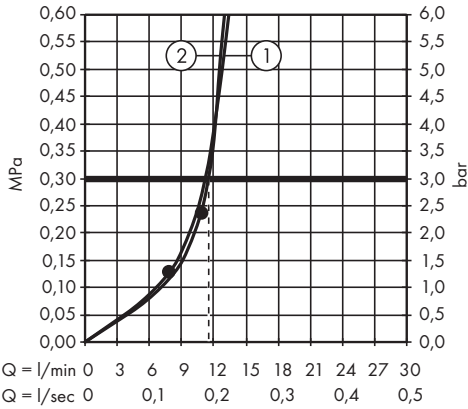
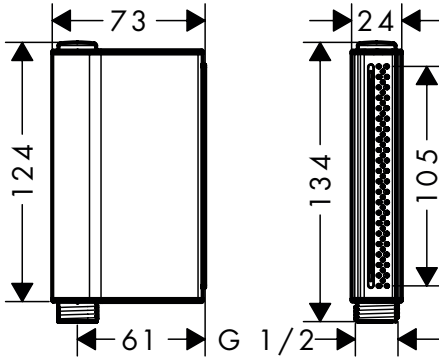

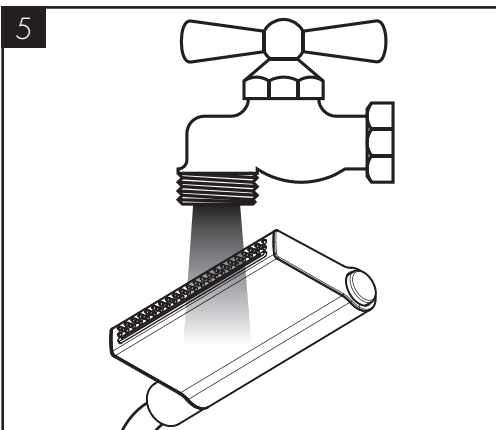
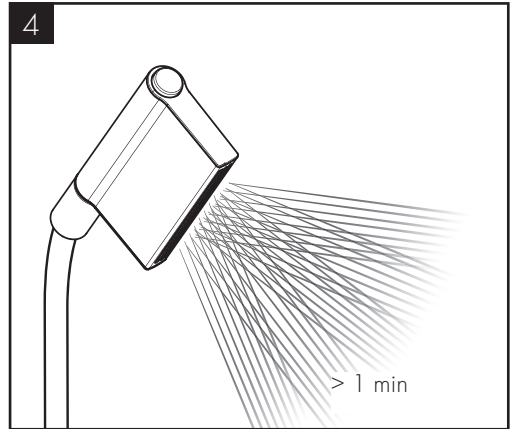
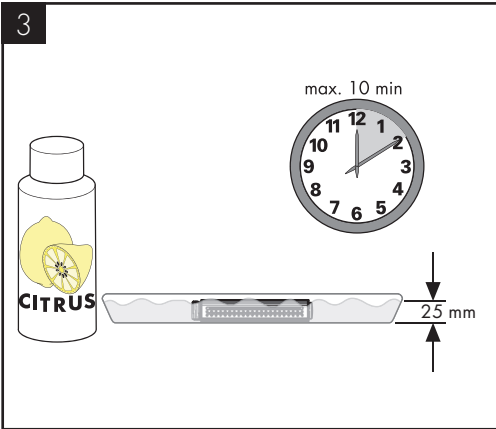
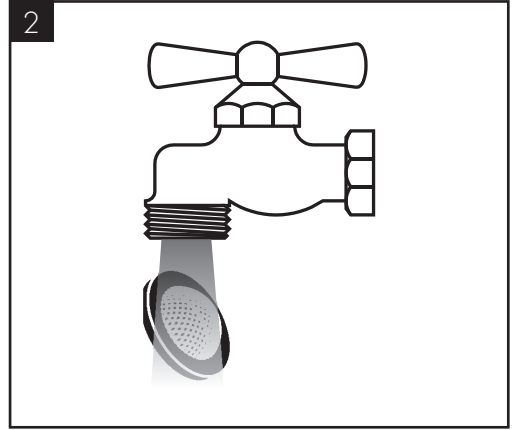
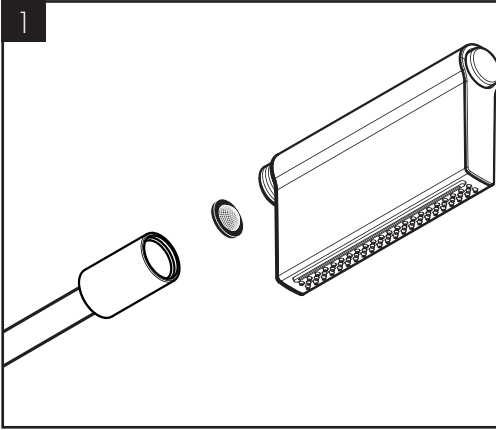

# AXOR

P-IX

DVGW

SVGW

ACS



ETA



GODKENDT  
TIL DRIKKEVAND

---

45720000

X

---

AXOR / Hansgrohe SE

Austraße 5-9

77761 Schiltach

Deutschland

[info@axor-design.com](mailto:info@axor-design.com)

[axor-design.com](http://axor-design.com)

12/2017  
9.04139.01